

ECON T PUMP SERIES

PERISTALTIC METERING PUMP

INSTALLATION AND MAINTENANCE MANUAL

 **WARNING**

TO BE INSTALLED AND MAINTAINED BY PROPERLY TRAINED PROFESSIONAL INSTALLER ONLY. READ MANUAL & LABELS FOR ALL SAFETY INFORMATION & INSTRUCTIONS.

TABLE OF CONTENTS

Warranty and Service Policy	3
Safety Instructions	4-6, 9, 12, 14-15, 17-21, 23-26
Materials of Construction	7
Accessories	8
Flow Rate Outputs	9
Operation	10-11
Programming	12-13
Installation	14-20
Troubleshooting	21-23
Tube Replacement	24-27
Cleaning the Point of Injection	28-30
Exploded View and Parts	31-32
Mounting Template	33

IMET 121125

WARRANTY AND CUSTOMER SERVICE

LIMITED WARRANTY

Stenner Pump Company will for a period of one (1) year from the date of purchase (proof of purchase required) repair or replace, at our option, all defective parts. Stenner is not responsible for any removal or installation costs. Pump tube assemblies and rubber components are considered perishable and are not covered in this warranty. Pump tube will be replaced each time a pump is in for service, unless otherwise specified. The cost of the pump tube replacement will be the responsibility of the customer. Stenner will incur shipping costs for warranty products shipped from our factory. Any tampering with major components, chemical damage, faulty wiring, weather conditions, water damage, power surges, or products not used with reasonable care and maintained in accordance with the instructions will void the warranty. Stenner limits its liability solely to the cost of the original product. We make no other warranty expressed or implied.

RETURNS

Stenner offers a 30-day return policy on factory direct purchases. Except as otherwise provided, no merchandise will be accepted for return after 30 days from purchase. To return merchandise at any time, call Stenner at 800.683.2378 for a Return Merchandise Authorization (RMA) number. A 15% re-stocking fee will be applied. Include a copy of your invoice or packing slip with your return.

DAMAGED OR LOST SHIPMENTS

Check your order immediately upon arrival. All damage must be noted on the delivery receipt. Call Stenner Customer Service at 800.683.2378 for all shortages and damages within seven (7) days of receipt.

SERVICE & REPAIRS

Before returning a pump for warranty or repair, remove chemical from pump tube by running water through the tube, and then run the pump dry. Following expiration of the warranty period, Stenner Pump Company will clean and overhaul any Stenner metering pump for a minimum labor charge plus necessary replacement parts and shipping. All metering pumps received for overhaul will be restored to their original condition. The customer will be charged for missing parts unless specific instructions are given. To return merchandise for repair, call Stenner at 800.683.2378 or 904.641.1666 for a Return Merchandise Authorization (RMA) number.

DISCLAIMER

The information contained in this manual is not intended for specific application purposes. Stenner Pump Company reserves the right to make changes to prices, products, and specifications at any time without prior notice.

TRADEMARKS

Santoprene® is a registered trademark of Celanese International Corporation.

IMPORTANT SAFETY INSTRUCTIONS

When installing and using this electrical equipment, basic safety precautions should always be followed, including the following:

1. READ AND FOLLOW ALL INSTRUCTIONS.

2 WARNING - VAC Models only - Risk of Electric Shock - This pump is supplied with a grounding conductor and grounding-type attachment plug. To reduce The Risk Of Electric Shock, Be Certain That It Is Connected Only To A Properly Grounded, Grounding-Type Receptacle.

3. WARNING - VAC Models only - To reduce the risk of electric shock, replace damaged cord immediately.

4. SAVE THESE INSTRUCTIONS.

SAFETY INFORMATION



⚠ WARNING Warns about hazards that CAN cause death, serious personal injury, or property damage if ignored.



ELECTRIC SHOCK HAZARD



⚠ WARNING **ELECTRIC SHOCK HAZARD**

Pump supplied with grounding power cord and attached plug. To reduce risk of electrical shock, connect only to a properly grounded, grounding type receptacle. Install only on a circuit protected by a Ground-Fault Circuit-Interrupter (GFCI). For locations other than US and Canada, pump must be supplied through a residual current device (RCD) with a rated residual operating current < 30 mA.



⚠ AVERTISSEMENT **DANGER DE CHOC ÉLECTRIQUE**

La pompe est dotée d'un cordon d'alimentation avec mise à la terre muni d'une fiche. Pour réduire le risque de choc électrique, branchez uniquement sur une prise correctement mise à la terre. Installez uniquement sur un circuit protégé par un disjoncteur différentiel. En dehors des États-Unis et du Canada, la pompe doit être alimentée par un dispositif à courant différentiel résiduel (RCD) fonctionnant à < 30 mA.



DO NOT alter the power cord or plug end.



DO NOT use receptacle adapters.



DO NOT use pump with a damaged or altered power cord or plug end. Contact the factory or an authorized service facility for repair.



⚠ WARNING **HAZARDOUS VOLTAGE**

DISCONNECT power cord before removing motor cover for service. **Electrical service by trained personnel only.**



⚠ WARNING **EXPLOSION HAZARD**

This pump is not explosion proof. **DO NOT** install or operate in an explosive environment.



⚠ WARNING **RISK OF EXPOSURE**

Potential for burns, fire, explosion, personal injury, or property damage. To reduce risk of exposure, the use of proper personal protective equipment is mandatory.



⚠ WARNING **RISK OF FIRE HAZARD**

DO NOT install or operate on any flammable surface.



⚠ WARNING **RISK OF CHEMICAL OVERDOSE**

To reduce risk, follow proper installation methods and recommendations. Check your local codes for additional guidelines.



⚠ WARNING To reduce the risk of injury, do not permit children to use this product.

This appliance is not to be used by persons with reduced physical, sensory or mental capabilities, or lack of experience and knowledge, unless they have been given supervision or instruction.

SAFETY INFORMATION continued



CAUTION Warns about hazards that **WILL** or **CAN** cause minor personal injury or property damage if ignored.



CAUTION PLUMBING:

Metering pump installation must always adhere to your local plumbing codes and requirements. Be sure installation does not constitute a cross connection. Check local plumbing codes for guidelines.



CAUTION This pump has been evaluated for use with water only.



NOTICE: Indicates special instructions or general mandatory action.



This metering pump is portable and designed to be removable from the plumbing system without damage to the connections.



Before installing or servicing the pump, read the pump manual for all safety information and complete instructions. The pump is designed for installation and service by properly trained personnel.



Installation of product must adhere to all regulatory and compliance codes applicable to the area.



This metering pump and its components have been tested for use with the following chemicals: Sodium Hypochlorite (10-15%), Muriatic Acid (20-22 Baume, 31.5% Hcl), and Soda Ash.



Cette pompe de dosage et ses composants ont été testés pour leur compatibilité avec les produits chimiques suivants : hypochlorite de sodium (10 à 15 %), acide chlorhydrique (20 à 22 % Baume, 31,5 % Hcl), et carbonate de sodium.



This metering pump is certified to ANSI/NSF 61 for use with Water and Sodium Hypochlorite 15%.



This is the safety alert symbol. When displayed in this manual or on the equipment, look for one of the following signal words alerting you to the potential for personal injury or property damage.



Acceptable for indoor use; or, outdoor use when mounted as shown in the Installation Section.



Destiné à une utilisation intérieure ou extérieure lorsqu'il le schéma de la section installation est respecté.



Electrical installation should adhere to all national and local codes. Consult a licensed professional for assistance with proper electrical installation.



Removing power from pool/spa recirculation pump must also remove power from feed pump.



The use of an auxiliary safety device (not supplied), such as a flow switch or sensor, is recommended to prevent feed pump operation in the event of a recirculation pump failure or if flow is not sensed.



Point of injection should be beyond all pumps, filters, and heaters.



Maximum temperature 40°C.

MATERIALS OF CONSTRUCTION

All Housings

Polycarbonate

Pump Tube & Check Valve Duckbill

Santoprene® (FDA approved)

Suction/Discharge Line & Ferrules

Polyethylene (FDA approved)

Suction Line Strainer & Cap

PVC or Polypropylene (both NSF listed); ceramic weight

Tube & Injection Fittings

PVC or Polypropylene (both NSF listed)

Connecting Nuts

PVC or Polypropylene (both NSF listed)

All Fasteners

Stainless Steel

ACCESSORIES

3 Connecting Nuts 1/4"

3 Ferrules 1/4" or 6 mm *Europe*

1 Injection Fitting 25 psi (1.7 bar) max.

or 1 Duckbill Check Valve 80 psi (5.5 bar) max.

1 Weighted Suction Line Strainer 1/4" or 6mm *Europe*

20' Suction/Discharge Line 1/4", white

or 20' Suction/Discharge Line 6 mm *Europe*, white

1 Additional Pump Tube

1 Quick Start Manual

1 Econ TD Addendum - Econ TD pumps only

FLOW RATE OUTPUTS

GALLONS & OUNCES

Pump Prefix	Pump Tube	Roller Assembly	Gallons per Day	Gallons per Hour	Ounces per Hour	Ounces per Minute	Pressure Max. psi
E10T1F	F	White	0.60	0.02	3.00	0.05	80
E10T2F	F	White	1.30	0.05	6.60	0.11	80
E20T4F	F	White	3.40	0.14	18.00	0.30	80
E20T4G	G	Black	12.30	0.51	65.40	1.09	80
E20T4H	H	Black	21.70	0.90	115.20	1.92	80
E10T1A	A	White	2.50	0.10	13.20	0.22	25
E10T2A	A	White	5.00	0.21	26.40	0.44	25
E10T2B	B	White	8.50	0.35	45.60	0.76	25
E10T2C	C	White	15.00	0.63	79.80	1.33	25

Approximate max. outputs @ 50/60Hz

LITERS & MILLILITERS

Pump Prefix	Pump Tube	Roller Assembly	Liters per Day	Liters per Hour	Milliliters per Hour	Milliliters per Minute	Pressure Max. bar
E10T1F	F	White	2.20	0.09	90.00	1.50	5.5
E10T2F	F	White	4.80	0.20	198.00	3.30	5.5
E20T4F	F	White	13.10	0.54	544.80	9.08	5.5
E20T4G	G	Black	46.50	1.94	1937.40	32.29	5.5
E20T4H	H	Black	82.00	3.41	3416.40	56.94	5.5
E10T1A	A	White	9.50	0.39	396.00	6.60	1.7
E10T2A	A	White	18.90	0.79	786.00	13.10	1.7
E10T2B	B	White	32.20	1.34	1338.00	22.30	1.7
E10T2C	C	White	56.80	2.37	2364.00	39.40	1.7

Approximate max. outputs @ 50/60Hz



NOTICE: The information within this chart is solely intended for use as a guide. The output data is an approximation based on pumping water under a controlled testing environment. Many variables can affect the output of the pump. Stenner Pump Company recommends that all metering pumps undergo field calibration by means of analytical testing to confirm their outputs.

OPERATION

CONTROL PANEL

The control panel has an LCD display to indicate the days of the week, event timer, operating mode and time. During operation the current day, time and operating mode is displayed. The operating modes are AUTO, OFF or ON.

Program up to 24 independent On and Off events within a 7 day period. Each event can be set for a specific On or Off time for each selected day(s) of the week. The timer is programmed in hour and minute increments.

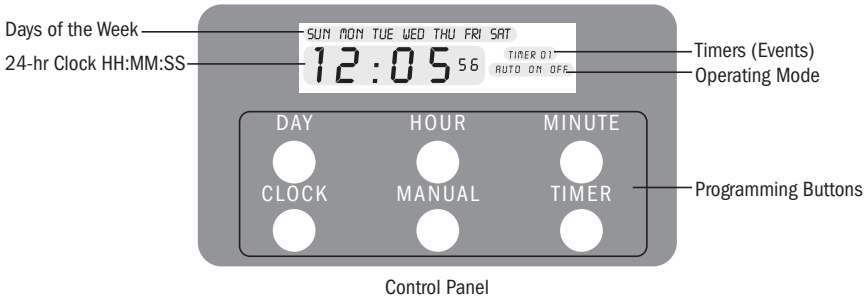

Programming Buttons

- DAY** Adjust day
- HOUR** Adjust hour
- MINUTE** Adjust minute
- CLOCK** 24-hr format., use with the DAY, HOUR & MINUTE button to set the current day and time
- MANUAL** Cycles pump between AUTO, ON & OFF
- TIMER** Use with DAY, HOUR, MINUTE buttons to program the on and off events

Programming Notes

When a timer has been initiated, the display will show the timer number (TIMER 01, TIMER 02, TIMER 03, etc.) and ON (blinking) to show that the pump is running a timer in AUTO mode.

Each separate ON and OFF event can run from a minimum of 1 minute to a maximum of 23 hours and 59 minutes within each programmed day.

OPERATION continued

CLOCK

The clock uses a 24-hour format for programming and can be set when the pump is not plugged in.

24-hr	12-hr
00:00	12 midnight
01:00	1 a.m.
02:00	2 a.m.
03:00	3 a.m.
04:00	4 a.m.
05:00	5 a.m.
06:00	6 a.m.
07:00	7 a.m.
08:00	8 a.m.
09:00	9 a.m.
10:00	10 a.m.
11:00	11 a.m.
12:00	Noon
13:00	1 p.m.
14:00	2 p.m.
15:00	3 p.m.
16:00	4 p.m.
17:00	5 p.m.
18:00	6 p.m.
19:00	7 p.m.
20:00	8 p.m.
21:00	9 p.m.
22:00	10 p.m.
23:00	11 p.m.

BACKUP BATTERY

The pump uses a single CR 1220 3V lithium battery to maintain the internal time. The battery should be changed annually.

If there is an AC power loss, the battery will maintain the time and the programmed events.

PROGRAMMING

! **NOTICE:** Indicates special instructions or general mandatory action.

FIRST TIME USE

! Before programming for the first time, the control panel must be reset to the default settings. Press and hold the CLOCK and TIMER buttons simultaneously for 5 seconds. The clock will display 00:00 and the timers will be disabled.

1. SET THE CLOCK

Press and hold down the CLOCK button, then press the DAY, HOUR, and MINUTE buttons to adjust to the current day and time.

When the current day and time is set, release the CLOCK button. The clock is now set.

2. PROGRAM THE FIRST TIMER: TIMER 01

a. Set the Time and the Day for the Pump to Start

Press the TIMER button once. The display will show TIMER 01 ON.

Press the DAY button to select the day or days that the timer will run. Press the DAY button repeatedly and the following choices will be displayed:

SUN = Sunday only

MON = Monday only

TUE = Tuesday only

WED = Wednesday only

THU = Thursday only

FRI = Friday only

SAT = Saturday only

SUN MON TUE WED THU FRI SAT = All days

MON TUE WED THU FRI = Monday through Friday

SUN SAT = Sunday and Saturday

MON WED FRI = Monday, Wednesday and Friday

TUE THU = Tuesday and Thursday

Press the HOUR and MINUTE buttons to set the ON time for the timer.

NOTE: Individual timers can be disabled by setting the on time hour and minutes to “- - : - -”.

b. Set the Time for the Pump to Stop

Press the TIMER button. The display will now show TIMER 01 OFF.

NOTE: The days selected for the ON time will be shown and cannot be changed.

Press the HOUR and MINUTE buttons to set the OFF time for the timer.

PROGRAMMING continued

3. SET ADDITIONAL TIMERS: TIMER 02 THROUGH 24, AS NEEDED

Press the **TIMER** button and repeat the above steps for each timer.

When finished setting the desired timers, press the **CLOCK** button to return to the operating display.

NOTE: DO NOT overlap timer programs. If timers are overlapped, the first timer to activate will run until the first OFF time of any overlapped timers is reached.

4. REVIEW PROGRAMS

Press the **TIMER** button repeatedly to view the settings for all 24 ON and OFF events.

Press the **CLOCK** button to return to the operating display and set the pump operation to **AUTO**. The display will show the current day, time, and the pump mode of operation.

5. OPERATING MODE

Auto

Press the **MANUAL** button to set pump to **AUTO**. The **AUTO** mode enables the timers to run at the programmed times and the display will show the last timer to run.

NOTE: When in **AUTO** mode, the display will show the last timer to run. If you enter into the timer programming menu and then come back out, it will clear the indicator of the last timer that ran and the timer indicator will be blank until a timer starts to run.

Manual

Manual mode is for priming only. If left in the manual mode, the pump will stop at midnight (00:00) and the operating mode will have to be manually set again.

To prime the pump, press the **MANUAL** button to set the pump to **ON**. When pump is set to **ON**, it will run continuously and bypass any programmed timers. To stop the pump from running in **MANUAL** or from running the programmed timers, press the **MANUAL** button to set the pump to **OFF**. The pump will remain off until the operating mode is changed to **ON** or **AUTO**.

INSTALLATION

ADDITIONAL SAFETY INSTRUCTIONS



NOTICE: Indicates special instructions or general mandatory action.



Read all safety hazards before installing or servicing the pump. The pump is designed for installation and service by properly trained personnel.



Use all required personal protective equipment when working on or near a metering pump.



Install the pump so that it is in compliance with all national and local plumbing and electrical codes.



Use the proper product to treat potable water systems, use only additives listed or approved for use.



Inspect tube frequently for leakage, deterioration, or wear. Schedule a regular pump tube maintenance change to prevent damage to pump and/or spillage.



Pump is not recommended for installation in areas where leakage can cause personal injury or property damage.

24VDC MODELS

POWER INSTRUCTIONS

24VDC Econ models can be controlled by turning on and off the 24VDC power. Electrical installation should adhere to all national and local codes. Consult a licensed professional for assistance with proper electrical installation. The installer is responsible for sizing the equipment used with this pump. Connect power lead wires to a 24VDC power supply.

Red = +24VDC

Black = -24VDC

FUSE INFORMATION

Pump is supplied with a standard 2 amp blade fuse located inside the housing. The fuse holder is taped to the bottom of the housing to keep wires contained when reassembling the pump.

If the fuse fails, there is an issue with the pump or power supply.

Identify and correct the issue before changing the fuse.

When changing the fuse be sure to reattach the fuse holder to the tape inside the housing.

INSTALLATION continued

MOUNT PUMP

- ❗ Select a dry location (to avoid water intrusion and pump damage) above the solution tank.
 - ❗ To prevent pump damage in the event of a pump tube leak, never mount the pump vertically with the pump head up.
 - ❗ DO NOT mount pump directly over an open solution tank. Keep tank covered.
 - ❗ Avoid flooded suction or pump mounted lower than the solution container. Draw solution from the top of the tank. Pump can run dry without damage. If pump is installed with a flooded suction, a shut-off valve or other device must be provided to stop flow to pump during service.
 - ❗ To prevent motor damage, verify with a volt meter that the receptacle voltage corresponds with the pump voltage.
 - ❗ For outdoor installation, the pump must be mounted vertically to comply with the outdoor rating.
1. Plug cord into the receptacle.
 2. Press the MANUAL button to set the pump to ON and verify the rotation of the roller assembly. Disconnect the power.



INSTALLATION DIAGRAM

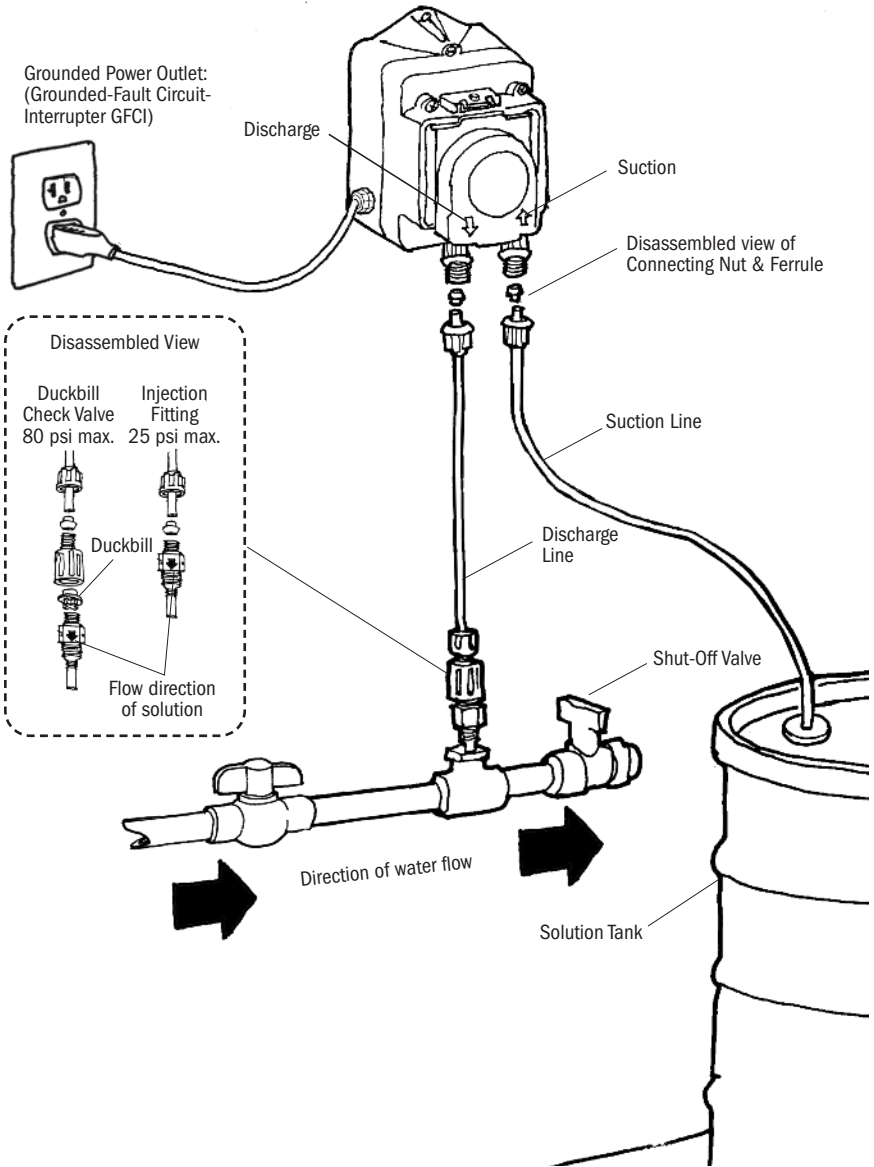

INSTALLATION continued

INSTALL SUCTION LINE TO PUMP HEAD

1. Uncoil the suction/discharge line. Use outside of solution tank as a guide to cut proper length of suction line ensuring it will be 2-3" above the bottom of solution tank.



Allow sufficient slack to avoid kinks and stress cracks. Always make a clean square cut to assure that the suction line is burr free. Normal maintenance requires trimming.



Suction lines that extend to the bottom of the tank can result in debris pickup leading to clogged injectors and possible tube failure.

2. Make connections by sliding the line(s) through connecting nut and ferrule and finger tighten to the corresponding tube fittings.

3. Finger tighten nut to the threaded tube fitting while holding the tube fitting.



Over tightening the nut with a wrench may result in damaged fittings, crushed ferrules, and air pick up.



DO NOT use thread sealant tape on pump tube connections or tools to tighten connections.

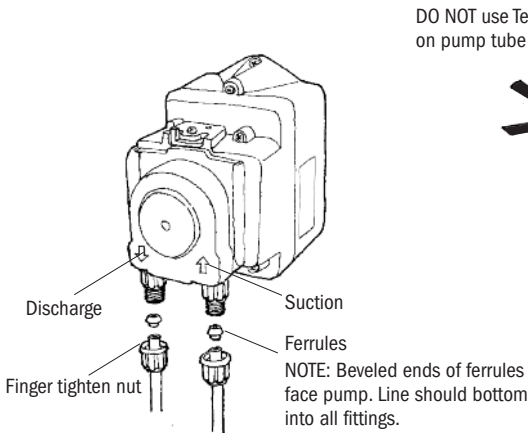

DO NOT use Teflon tape on pump tube threads.

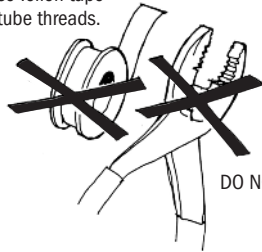

DO NOT use pliers.

INSTALLATION continued

INSTALL SUCTION WEIGHT TO SUCTION LINE

1. Drill a hole into the bung cap or solution tank lid. Slide the line through and secure the weighted strainer to the line.
2. To attach the strainer, push approximately 3.5" of suction line through the cap on the strainer body. Pull line to make sure it is secure.
3. Suspend slightly above tank bottom to reduce the chance of sediment pickup.



DO NOT mix additives in the solution container. Follow recommended mixing procedures according to the manufacturer.



DO NOT operate pump unless additive is completely in solution. Turn pump off when replenishing solution.



DO NOT slide line all the way to the bottom of the weighted strainer. Line could become flush with the nose of the strainer and the pump may not prime due to blockage.

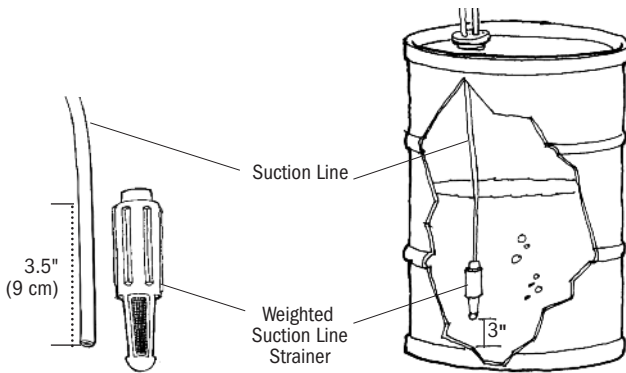

INSTALLATION continued

INSTALL DISCHARGE LINE TO PUMP HEAD AND INJECTION POINT

1. Make a secure finger tight connection on the discharge fitting of the pump head as instructed in Install Suction Line instructions.
- !** **DO NOT use thread sealant tape on pump tube connections or tools to tighten connections.**
- !** **WARNING** **HAZARDOUS PRESSURE: Shut off water or circulation system and bleed off any system pressure.**
2. **!** **Locate a point of injection beyond all pumps and filters or as determined by the application.**
2. A 1/4" or 1/2" Female NPT (FNPT) connection is required for installing the injection fitting. If there is no FNPT fitting available, provide one by either tapping the pipe or installing FNPT pipe tee fitting.
 3. Wrap the Male NPT (MNPT) end of injection fitting with 2 or 3 turns of threading tape. If necessary, trim the injection fitting quill as required to inject product directly into flow of water.

DO NOT use Teflon tape on pump tube threads.

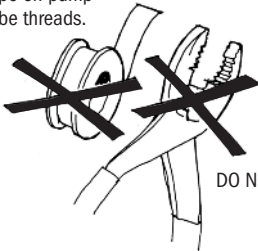

DO NOT use pliers.

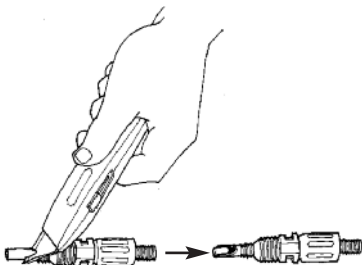

Trim injection fitting end

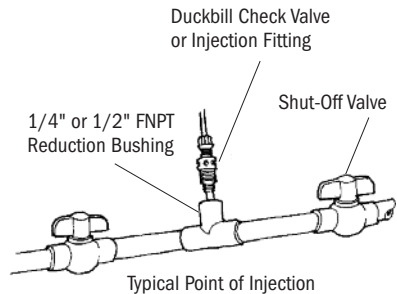

INSTALLATION continued

4. Hand tighten the injection fitting into the FNPT fitting.
 - a. Install connecting nut and ferrule to the pump discharge line. Insert discharge line into injection fitting until it reaches base of fitting.
 - b. Finger tighten connecting nut to fitting.
5. Turn the pump on and re-pressurize the system. Prime the pump and observe the flow. Check all connections for leaks. Once primed, place the pump in the desired operating mode.
6. After suitable amount of dosing time, perform tests for desired readings (e.g., pH or ppm). If necessary, fine tune dosing levels by adjusting the run time per event.



The injection point and fitting require periodic maintenance to clean any deposits or buildup. To allow quick access to the point of injection, Stenner recommends the installation of shut-off valves.

TROUBLESHOOTING DRIVE ASSEMBLY



WARNING

HAZARDOUS VOLTAGE:

DISCONNECT power before service. **Electrical service should be performed by trained personnel only.**

PROBLEM	POSSIBLE CAUSE	SOLUTION
Loud or excessive noise	Insufficient gear lubrication Worn gears or gear posts	Apply AquaShield to gears and gear posts Inspect/replace gears and gear posts
Drive assembly does not work	Faulty electrical supply Damaged DC motor Damaged power cord	Check electrical supply Replace drive assembly Replace drive assembly
Drive assembly runs; output shaft does not turn	Worn or damaged gears Damaged circuit board	Replace gears as needed Replace drive assembly
Phenolic gear is stripping	Worn gear posts Rusted helical gear Insufficient lubrication	Replace gear posts & affected gears Buff off helical gear and replace phenolic gear Apply AquaShield to gears and gear posts

TROUBLESHOOTING PUMP HEAD

PROBLEM	POSSIBLE CAUSE	SOLUTION
Components are cracking	Chemical attack Chemical intrusion from tube failure	Check chemical compatibility Identify and correct cause. Clean components of chemical and replace tube according to manual
Pump head leaking	Pump tube rupture	Identify and correct cause. Clean components of chemical and replace tube and ferrules according to manual
No pump output; pump head rotates	Depleted solution tank or weighted strainer is above solution Leak in the suction line or at connections Ferrules installed incorrectly, missing or damaged Injection point is clogged Clogged suction and/or discharge line and/or check valve Life of pump tube is exhausted Suction line is flush with the nose of the weighted strainer Pump cover not secured properly	Replenish solution and position suction line 3" above bottom of tank Correct or replace suction line, and/or connections Replace ferrules, beveled end faces pump Inspect and clean injection point Clean and/or replace as needed Replace tube and ferrules according to manual and schedule tube replacement based on application Pull suction line approximately 1" from bottom of strainer; cut bottom of suction line at an angle Ensure pump cover latch is fully closed
Low pump output; pump head rotates	Life of pump tube exhausted Rollers worn or broken Injection point is restricted Incorrect tube size or setting High system back pressure Incorrect programming Pump cover not secured properly	Replace tube and ferrules according to manual and schedule tube replacement based on application Replace roller assembly Inspect and clean injection point regularly Refer to flow rate output chart and determine correct setting or replace tube with correct size Confirm system pressure does not exceed 80 psi (5.5 bar) maximum Review sizing and programming Ensure pump cover latch is fully closed
No pump output; pump head doesn't rotate	Stripped roller assembly hub Faulty board Drive assembly problem Incorrect programming	Replace roller assembly Replace drive assembly Refer to drive assembly troubleshooting Review sizing and programming
Pump output is high	Incorrect tube size or setting Roller assembly is broken Incorrect programming	Refer to flow rate output chart and determine correct setting or replace tube with correct size Replace roller assembly Review sizing and programming

TROUBLESHOOTING PUMP TUBE







! **NOTICE:** A leaking pump tube damages the metering pump. Inspect pump frequently for leakage and wear. Refer to Tube Replacement section for additional safety precautions and instructions.

PROBLEM	POSSIBLE CAUSE	SOLUTION
Tube leaking	Pump tube ruptured	Identify and correct cause. Clean components of chemical and replace tube and ferrules according to manual.
	Mineral deposits at injection point	Clean injection fitting. Replace pump tube, ferrules and duckbill according manual.
	Excessive back pressure 80 psi (5.5 bar) maximum	Verify system pressure against tube psi, replace tube and ferrules
	Tube is twisted	Replace tube & ferrules according to manual, hold tube fitting while tightening connecting nut to prevent twisting.
	Tube not centered	Clean components of chemical, replace tube and ferrules according to manual & confirm tube is centered
Tube life is shortened	Chemical attack	Check chemical compatibility
	Mineral deposits at injection point	Clean injection fitting. Replace tube, ferrules & duckbill according to manual
	Sediment blockage at injection fitting	Clean injection fitting, ensure suction line is 3" above tank bottom; use suction line strainer
	Seized rollers caused abrasion on tube	Clean roller assembly or replace, do not lubricate
	Exposure to heat or sun	Do not store tubes in high temperatures or in direct sunlight
Tube connection is leaking or damaged	Ferrules installed incorrectly, missing or damaged	Replace ferrule, beveled end faces pump

TUBE REPLACEMENT SAFETY INFORMATION



WARNING RISK OF EXPOSURE

-  To reduce risk of exposure, check the pump tube regularly for leakage. At the first sign of leakage, replace the pump tube.
-  To reduce risk of exposure, the use of proper personal protective equipment is mandatory when working on or near metering pumps.
-  To reduce risk of exposure, and also prior to service, shipping, or storage, pump generous amounts of water or a compatible buffer solution to rinse pump.
-  Consult SDS sheet for additional information and precautions for the additive in use.
-  Personnel should be skilled and trained in the proper safety and handling of the additive in use.
-  Inspect tube frequently for leakage, deterioration, or wear. Schedule a regular pump tube maintenance change to prevent damage to pump and/or spillage.





CAUTION PINCH POINT HAZARD

-  Use extreme caution when replacing pump tube. Be careful of your fingers and **DO NOT** place fingers near rollers.







WARNING HAZARDOUS PRESSURE EXPOSURE

-  Use caution and bleed off all resident system pressure prior to attempting service or installation.
-  Use caution when disconnecting discharge line from pump. Discharge may be under pressure. Line may contain fluid being metered.



NOTICE: Indicates special instructions or general mandatory action.

-  **DO NOT** apply grease, oil, or lubricants to the pump tube or housing.
-  Prior to pump tube replacement, inspect the entire pump head for cracks or damaged components. Ensure rollers turn freely.
-  Rinse off fluid residual and clean all fluid and debris from pump head components prior to tube replacement.
-  **DO NOT** pull excessively on pump tube. Avoid kinks or damage during tube installation.
-  Inspect the suction/discharge line, injection point (into pipe), and injection fitting for blockages after any tube rupture. Clear or replace as required.

TUBE REPLACEMENT

PREPARATION

1. Follow all safety precautions prior to tube replacement.
2. Prior to service, pump water or a compatible buffer solution through the pump and suction and discharge lines to remove fluid and avoid contact.
3. Unplug the pump.
4. Disconnect the suction and discharge connections from pump head.

TUBE REPLACEMENT continued

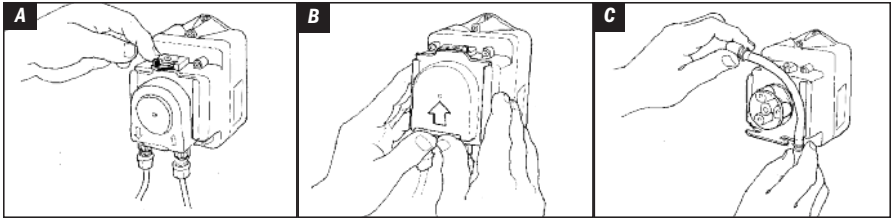

REMOVE TUBE

! Always unplug pump before doing maintenance work.

1. Unplug the pump.
2. Remove the Phillips head locking screw on the latch (CE models only). Slide the vertical tab 180 degrees from left to right to unlock the cover latch. **A**
3. To slide cover off, push up on the raised edge. **B**
4. Release the fittings from the slots to remove the tube. **C**
5. Remove roller assembly.
6. Use non-citrus all-purpose cleaner to clean residue from pump head housing, roller, and cover.
7. Check cover for cracks. Replace if cracked.
8. Ensure rollers spin freely.
9. Replace roller assembly if: seized, excessive side play from bore wear, or if rollers are visibly worn.
10. Re-install roller assembly.

TUBE REPLACEMENT continued

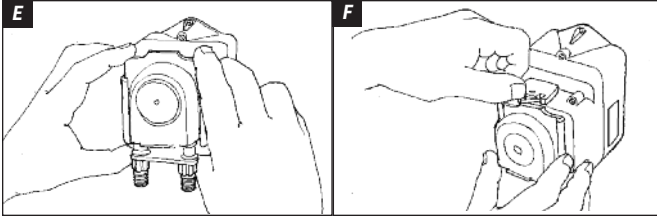
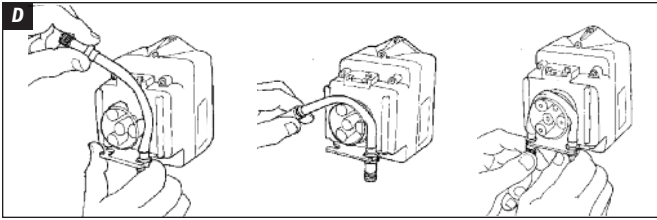

INSTALL NEW TUBE

1. To install new tube, insert one fitting into slot, pull tube around the center of the roller assembly and insert second fitting into the other slot. **D**
2. Align tube housing cover with track and slide over tube until fully closed. **E**
3. Plug the pump in.
4. Run the pump for one minute to relax the tube. Press the MANUAL button to set the pump to ON. When pump is set to ON, it will run continuously and bypass any programmed timers. To stop the pump from running in MANUAL or from running the programmed timers, press the MANUAL button to set the pump to OFF. The pump will remain off until the operating mode is changed to ON or AUTO.
5. To lock cover in place, press down on the cover while turning the vertical tab 180 degrees from right to left. Install the Phillips head locking screw (CE models only). **F**
6. Run the pump for one minute to verify operation.
7. Reconnect the suction and discharge lines.
8. Prime the pump and then set it to the desired operating mode.

CLEANING THE POINT OF INJECTION

SAFETY INFORMATION

NOTICE: Indicates special instructions or general mandatory action.

Pumps, 25 psi maximum, are installed using an injection fitting and 80 psi maximum use an duckbill check valve. Both allow the extension tip to be installed in the center of the pipe directly in the flow of water to help reduce deposit accumulation.

WARNING Warns about hazards that CAN cause death, serious personal injury, or property damage if ignored.

This is the safety alert symbol. When displayed in this manual or on the equipment, look for one of the following signal words alerting you to the potential for personal injury or property damage.

WARNING HAZARDOUS PRESSURE/CHEMICAL EXPOSURE

- Use caution and bleed off all resident system pressure prior to attempting service or installation.
- Use caution when disconnecting discharge line from pump. Discharge line may be under pressure. Discharge line may contain chemical.
- To reduce risk of exposure, the use of proper personal protective equipment is mandatory when working on or near chemical metering pumps.

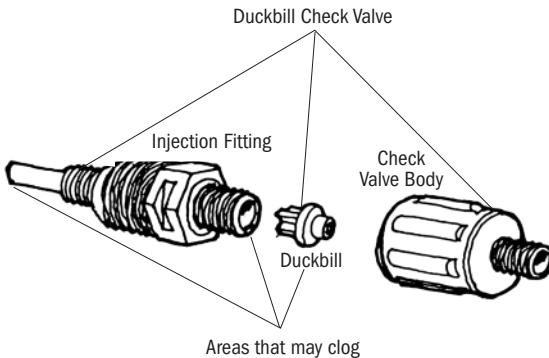

CLEANING THE POINT OF INJECTION continued

1. Turn metering pump off and unplug cord. Disable water pump or auxiliary equipment electrical supply.
2. Depressurize system and bleed pressure from pump discharge line.
3. Loosen and remove connecting nut and ferrule from the duckbill check valve or injection fitting to disconnect discharge line.

Pump 80 psi max., go to 4.

Pump 25 psi max., skip 4 and go to 5.

4.
 - Unscrew the top fitting (check valve body) to disassemble. The bottom fitting (injection fitting with arrow) should remain attached to the pipe.
 - Remove duckbill from check valve body and replace if deteriorated or swollen (replace duckbill with every tube change). If clogged, clean or replace (yearly replacement recommended).
 - Examine O-ring in the injection fitting and replace if deteriorated or damaged.
5. Insert a #2 Phillips head screwdriver through injection fitting into the pipe to locate or break up accumulated deposits. If screwdriver cannot be inserted, drill the deposit out of the injection fitting (DO NOT drill through the opposite pipe wall.)

More on next page

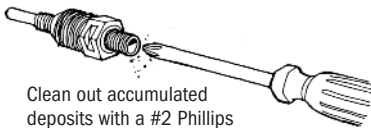
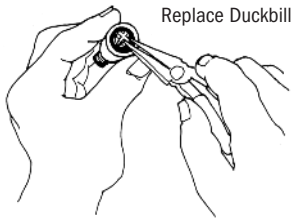

Clean out accumulated deposits with a #2 Phillips head screwdriver.

Periodic inspection and cleaning of the point of injection will maintain proper pump operation and provide maximum tube life.

CLEANING THE POINT OF INJECTION continued

6. Replace discharge line if cracked or deteriorated. If the end is clogged, cut off the calcified or blocked section of discharge line.
7. **Pump 80 psi max.**
 - a. Reassemble the duckbill check valve.
 - b. Replace ferrule and reinstall the discharge line to the duckbill check valve approximately 3/4" until it stops.**Pump 25 psi max.**

Replace ferrule and reinstall the discharge line to the injection fitting approximately 3/4" until it stops.
8. Tighten the connection nut finger tight.
9. Enable the water pump electrical supply and pressurize the water system.
10. Put the metering pump back in service and inspect all connections for leaks.

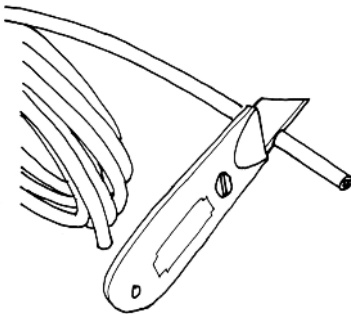

Cut off the calcified or blocked section.

EXPLODED VIEW

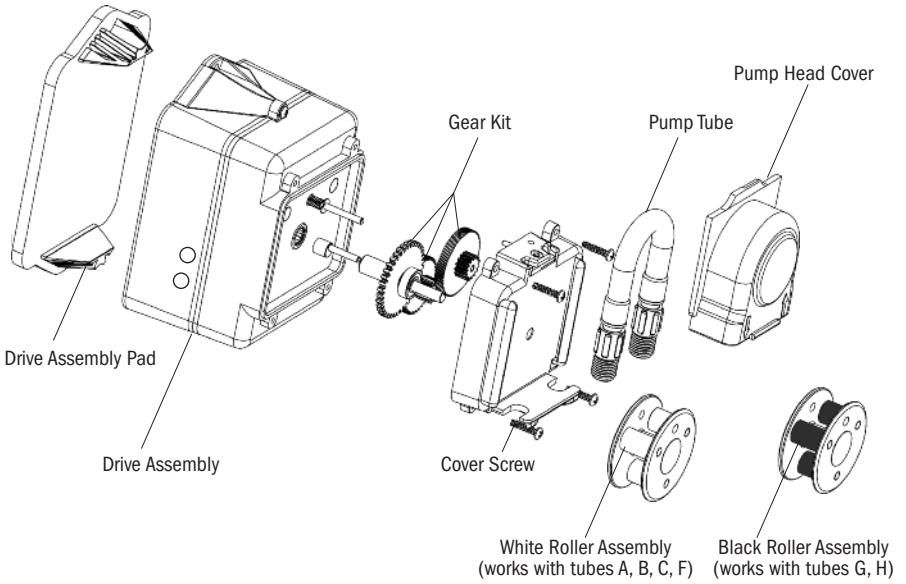

PARTS

Pump Tubes

Includes tube, ferrules 1/4" or Europe 6 mm

DESCRIPTION	UM	Insert tube # for □	
		PART NUMBER	Europe 6 mm
A, B or C Santoprene® tube	2-PK	EC30□-2	EC30□CE-2
F, G or H Santoprene® tube & Duckbill	2-PK	EC30□-2	EC30□CE-2

Pump Head Parts

DESCRIPTION	UM	PART NUMBER
Roller Assembly, white <i>Tubes A, B, C & F</i>	EA	EC350
Roller Assembly, black <i>Tubes G & H</i>	EA	EC351
Pump Head Cover	EA	EC355

Motor Parts

DESCRIPTION	UM	PART NUMBER
Gear Kit with spacers, screws & AquaShield <i>E10 prefix pumps</i>	KIT	EC310
Gear Kit with spacers, screws & AquaShield <i>E20 prefix pumps</i>	KIT	EC320
Drive Assembly Pad	EA	EC302
Mounting Kit <i>for wall mount or Stenner tank</i>	KIT	EC303
Pump Stand <i>for horizontal display or wall mount</i>	KIT	EC304

NOTE: Econ TD specific parts are listed in the Econ TD manual addendum.

MOUNTING TEMPLATE

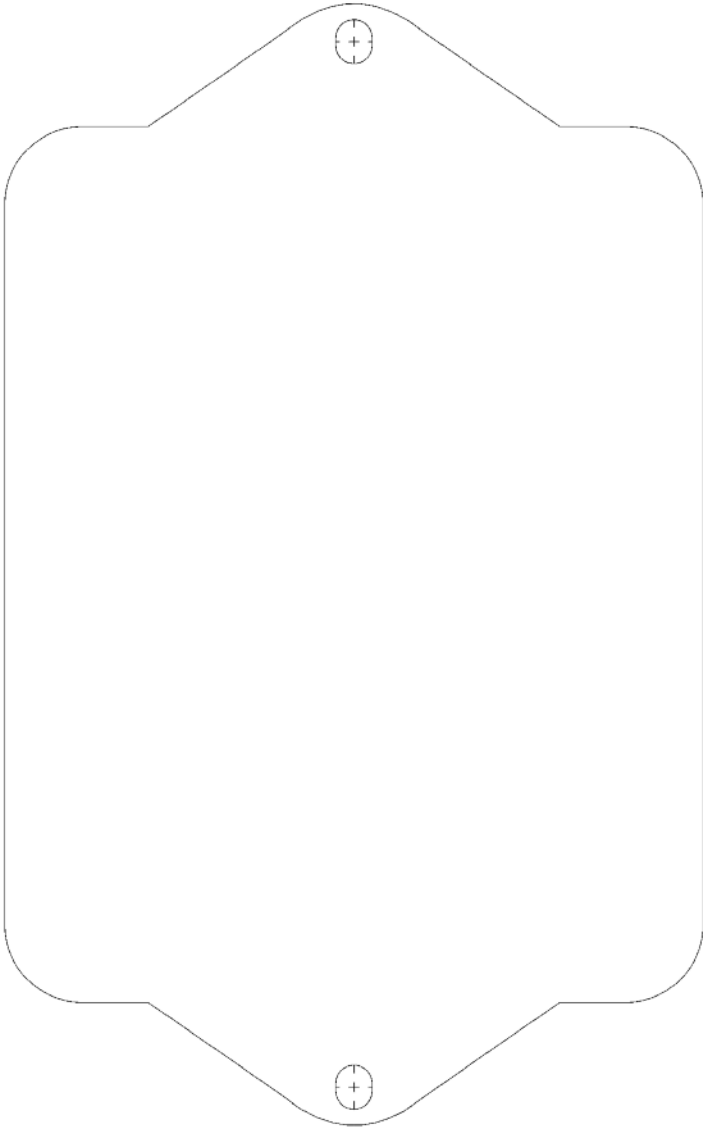

STENNER PUMPS[®]

STENNER PUMP COMPANY

3174 DeSalvo Road
Jacksonville, Florida 32246 USA

Phone: 904.641.1666

US Toll Free: 800.683.2378

Fax: 904.642.1012

sales@stenner.com

www.stenner.com

Hours (EST)

Mon.-Fri. 7:00 am-8:00 pm

 Assembled in the USA
with US and international components

© Stenner Pump Company
All Rights Reserved